

BESSEY Accessories and spare parts list 2025/2026

4-7 Malleable cast iron screw clamps



TG / TPN
TGK / TKPN
TGNT

8-11 All-steel screw clamps



GZ / GS
G...Z
GU25-12-6ZK
GMZ

12-13 Lever clamps



GH / GSH
GHS / G...H

14-15 High-performance clamps



SLM / SGM / SGL
SG...M / STBM
STBS / STBVC
SGU / STBU
GSL / GSM

16 Variable screw clamps



SLV / GSV

17 Claw clamps



GRA...12

17 Toggle clamps



STC-VH / STC-HH
STC-HV / STC-HA
STC-IHH / STC-IHA
TW..A-STC
TW..VAD / TWVAD

18-20 Clamping elements



TWV / TW
TWM28
TW28GRS
WNS-SET-MFT

21 Machine table clamps



BAS
BSN
SGHS

22 K Body parallel clamp REVO



KRE / KREV
KR / KRV / K

23 Box clamp



KS

23 Area pressure clamps



FK

23 GearKlump



GK

24 One-handed clamps



EHZ / EZS / EZ

25 Rafter clamps



SPZ

26 Grip pliers



26 KliKlamp



27 Mini Vice and Angle clamp



27 Table clamps



28 Band clamps



29 Kantenfix and panel carrier



29 Seaming tools



30-31 Door frame and window assembly tools

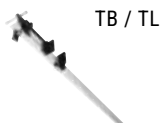
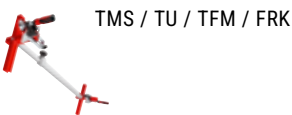

32-33 Telescopic drywall support



34 Compound leverage snips



35 Standard tin snips



36 Folding utility knives



The BESSEY Product Development Department reserves the right for technical alterations. Errors and omissions excepted – to the best of our knowledge the information supplied is accurate.

BESSEY Accessories and spare parts list 2025/2026





Malleable cast iron screw clamps

suitable for series TG and TPN

	Lower part cpl. with 2-component plastic handle		2-component plastic handle, incl. high-quality steel pressure plate with protection cap			Sliding arm cpl. with wooden handle		Wooden handle, incl. high-quality steel pressure plate with protection cap		
	Throat depth mm	For rail mm	Length x Ø mm	Head Ø mm	Acme thread mm	Throat depth mm	For rail mm	Length x Ø mm	Head Ø mm	Acme thread mm
TG10 / TG...B5										
Order-No.	-		-			-		-		
TG12 / TG...B6										
Order-No.	-		-			-		-		
TG16 TG...B8 TPN16 TPN...B8			110 x 30	10	14 x 4					
Order-No.	-		3101179			-		-		
TG20 TG...S10 TPN20 TPN...S10			110 x 30	12	16 x 4	100	27 x 7	112 x 30	12	16 x 4
Order-No.	-		3101182			3101413		3101386		
TG25 TG...S12 TPN25 TPN...S12	120	29 x 9	130 x 34	12	16 x 4	120	29 x 9	125 x 32	12	16 x 4
Order-No.	3101832		3101186			3101414		3101389		
TG30 TG...S14 TPN30 TPN...S14	140	32 x 10	130 x 34	13	18 x 5	140	32 x 10	140 x 35	13	18 x 5
Order-No.	3101833		3101187			3101415		3101390		
TG40 TG...S17	175	32 x 10	130 x 34	13	18 x 5	175	32 x 10	140 x 35	13	18 x 5
Order-No.	3101834		3101187			3101416		3101390		
TPN40 TPN...S17	175	32 x 10	130 x 34	13	18 x 5	175	32 x 10	140 x 35	13	18 x 5
Order-No.	3101834		3101187			3101416		3101390		

Malleable cast iron screw clamps

suitable for series TG and TPN





	Pressure plate with protection cap changeable from size 16	Protection cap for moveable jaw & for fixed jaw		Pressure cap strips	Tommy bar accessory KA
	 4 pairs	 10 pairs		 2 pcs.	 2 pcs.
	Ø mm	For Ø mm	For width mm		only suitable for tommy bar versions
TG10 / TG...B5	22	22	17		
Order-No.	3101339	3101391		-	-
TG12 / TG...B6	22	22	19		
Order-No.	3101339	3101392		-	-
TG16 TG...B8 TPN16 TPN...B8	25,5	25,5	23		
Order-No.	3101180	3101393		-	-
TG20 TG...S10 TPN20 TPN...S10	32	32	28		
Order-No.	3101183	3101394		-	3101194*
TG25 TG...S12 TPN25 TPN...S12	32	32	30		
Order-No.	3101183	3101395		-	3101194*
TG30 TG...S14 TPN30 TPN...S14	38,5	38,5	32		
Order-No.	3101188	3101396		-	3101194*
TG40 TG...S17	38,5	38,5	32		
Order-No.	3101188	3101396		-	3101194*
TPN40 TPN...S17	38,5				
Order-No.	3101188	-		SKS20/40	3101194*

*While stocks last

BESSEY Accessories and spare parts list 2025/2026





Heavy duty malleable cast iron screw clamps

suitable for series TGK and TKPN

	Lower part cpl. with 2-component plastic handle		2-component plastic handle, incl. high-quality steel pressure plate with protection cap			Sliding arm cpl. with wooden handle		Wooden handle, incl. high-quality steel pressure plate with protection cap		
										
	Throat depth mm	For rail mm	Length x Ø mm	Head Ø mm	Acme thread mm	Throat depth mm	For rail mm	Length x Ø mm	Head Ø mm	Acme thread mm
TGK TKPN	120	35 x 11	130 x 34	13	18 x 5	120	35 x 11	140 x 35	13	18 x 5
Order-No.	3101838		3101187			3101417		3101390		





Heavy duty malleable cast iron screw clamps

suitable for series TGK and TKPN

	Tommy bar		Pressure plate with protection cap	Pressure cap strips SKS		Tommy bar accessory KA
						
	Throat depth mm	For rail mm	4 pairs	For Ø mm	For width mm	2 pcs.
TGK TKPN			38,5	25,5	23	only suitable for tommy bar versions
Order-No.	-		3101188	SKS20/40		3101194*
TGK-K	120	35 x 11	38,5	25,5	23	
Order-No.	3101418		3101188	SKS20/40		3101194*

Deep throat clamps





suitable for series TGNT

	Lower part cpl. with wooden handle		Wooden handle, incl. high-quality steel pressure plate with protection cap			Pressure plate with protection cap	Tommy bar accessory KA
							
						4 pairs	2 pcs.
	Throat depth mm	For rail mm	Length x Ø mm	Head Ø mm	Acme thread mm	Ø mm	only suitable for tommy bar versions
TGN...T20	200	35 x 11	140 x 35	13	18 x 5	38,5	
Order-No.	3101419		3101390			3101188	3101194*
TGN...T25	250	40 x 11	140 x 35	13	18 x 5	38,5	
Order-No.	3101420		3101390			3101188	3101194*
TGN...T30	300	45 x 12	140 x 35	13	18 x 5	38,5	
Order-No.	3101421		3101390			3101188	3101194*
TGN...T40			140 x 35	13	18 x 5	38,5	
Order-No.	-		3101390			3101188	3101194*
TGN...T50			140 x 35	13	18 x 5	38,5	
Order-No.	-		3101390			3101188	3101194*

BESSEY Accessories and spare parts list 2025/2026





All-steel screw clamps – new version from 01.07.09

suitable for series GZ

Sliding arm cpl. with 2-component plastic handle		2-component plastic handle, incl. high-quality steel pressure plate with protection cap			Sliding arm cpl. with wooden handle		Wooden handle, incl. high-quality steel pressure plate with protection cap			
										
Throat depth mm	For rail mm	Length x Ø mm	Head Ø mm	Acme thread mm	Throat depth mm	For rail mm	Length x Ø mm	Head Ø mm	Acme thread mm	
GZ10 / GZ12										
Order-No.	-		-			-		-		
GZ16		110 x 30	10	14 x 4						
Order-No.	-	3101179				-		-		
GZ20 GZ...-10	100	22 x 8,5	110 x 30	12	16 x 4	100	22 x 8,5	112 x 30	12	16 x 4
Order-No.	3101955		3101182			3101516		3101386		
GZ25 GZ...-12	120	24 x 9,5	130 x 34	12	16 x 4	120	24 x 9,5	125 x 32	12	16 x 4
Order-No.	3101835		3101186			3101517		3101389		
GZ30	140	28 x 11	130 x 34	13	18 x 5	140	28 x 11	140 x 35	13	18 x 5
Order-No.	3101836		3101187			3101518		3101390		
GZ40 – GZ125	120	28 x 11	130 x 34	13	18 x 5	120	28 x 11	140 x 35	13	18 x 5
Order-No.	3101837		3101187			3101519		3101390		

All-steel screw clamps – new version from 01.07.09

suitable for series GZ

Sliding arm cpl. with tommy bar		Tommy bar	2-component plastic swivel handle, incl. high-quality steel pressure plate with protection cap			Pressure plate with protection cap changeable from size 16	Tommy bar accessory KA
							
Throat depth mm	For rail mm	Acme thread mm	Length x Ø mm	Head Ø mm	Acme thread mm	4 pairs	2 pcs.
						Ø mm	only suitable for tommy bar versions
GZ10 / GZ12						22	
Order-No.	-		-			3101339	-
GZ16						25,5	
Order-No.	-		-			3101180	-
GZ20 GZ...-10	100	22 x 8,5	16 x 4			32	
Order-No.	3101441		3101796			3101183	3101194*
GZ25 GZ...-12	120	24 x 9,5	16 x 4			32	
Order-No.	3101444		125 x 35	12	16 x 4	3101183	3101194*
			3101958				
GZ30	140	28 x 11	18 x 5			38,5	
Order-No.	3101447		3101797			3101188	3101194*
GZ40 – GZ125	120	28 x 11	18 x 5			38,5	
Order-No.	3101450		3101797			3101188	3101194*

*While stocks last

BESSEY Accessories and spare parts list 2025/2026

OMEGA screw clamps, All-steel screw clamps classiX and

All-steel screw clamps – old version up 30.06.09



suitable for series GMZ, G...Z, GS

	Sliding arm cpl. with wooden handle		Sliding arm cpl. with tommy bar		Wooden handle, incl. high-quality steel pressure plate with protection cap			2-component plastic handle, incl. high-quality steel pressure plate with protection cap		
	Throat depth mm	For rail mm	Throat depth mm	For rail mm	Length x Ø mm	Head Ø mm	Acme thread mm	Length x Ø mm	Head Ø mm	Acme thread mm
G10Z / G12Z GS10 / GS12										
Order-No.	-		-		-			-		
G16Z / GS16								110 x 30	10	14 x 4
Order-No.	-		-		-			3101179		
G20Z/G...-S10Z GS20 GM20Z GM...S10Z	100	19,5 x 9,5	100	19,5 x 9,5	112 x 30	12	16 x 4	110 x 30	12	16 x 4
Order-No.	3101422		3101800		3101386			3101182		
G25Z/G...-S12Z GS25 GM25Z GM...-S12Z GU25-12-6ZK	120	22 x 10,5	120	22 x 10,5	125 x 32	12	16 x 4	130 x 34	12	16 x 4
Order-No.	3101423		3101801		3101389			3101186		
G30Z / GS30 GM30Z	140	25 x 12	140	25 x 12	140 x 35	13	18 x 5	130 x 34	13	18 x 5
Order-No.	3101424		3101802		3101390			3101187		
G40Z – G60Z GS40 – GS60 GM40Z – GM60Z	120	25 x 12	120	25 x 12	140 x 35	13	18 x 5	130 x 34	13	18 x 5
Order-No.	3101425		3101803		3101390			3101187		
G80Z – G125Z GS80 – GS100 GM80Z – GM125Z	120	27 x 13	120	27 x 13	140 x 35	13	18 x 5	130 x 34	13	18 x 5
Order-No.	3101426		3101804		3101390			3101187		

OMEGA screw clamps, All-steel screw clamps classIX and

All-steel screw clamps – **old version up 30.06.09**

suitable for series GMZ, G...Z, GS



	Tommy bar	Pressure plate with protection cap changeable from size 16	Tommy bar accessory KA
			
		4 pairs	2 pcs.
	Acme thread mm	Ø mm	only suitable for tommy bar versions
G10Z / G12Z GS10 / GS12		22	
Order-No.	-	3101339	-
G16Z / GS16	14 x 4	25,5	
Order-No.	3101795	3101180	-
G20Z/G...S10Z GS20 GM20Z GM...S10Z	16 x 4	32	
Order-No.	3101796	3101183	3101194*
G25Z/G...S12Z GS25 GM25Z GM...S12Z GU25-12-6ZK	16 x 4	32	
Order-No.	3101796	3101183	3101194*
G30Z / GS30 GM30Z	18 x 5	38,5	
Order-No.	3101797	3101188	3101194*
G40Z – G60Z GS40 – GS60 GM40Z – GM60Z	18 x 5	38,5	
Order-No.	3101797	3101188	3101194*
G80Z – G125Z GS80 – GS100 GM80Z – GM125Z	18 x 5	38,5	
Order-No.	3101797	3101188	3101194*

*While stocks last

BESSEY Accessories and spare parts list 2025/2026



Lever clamps – GH – new version from 01.03.10

suitable for series GH

	Sliding arm cpl.		Lever pressure plate cpl.	Trigger cpl.
				
			2 pcs.	
	Throat depth mm	For rail mm	Bolt-Ø x l mm	Bolt-Ø x l mm
GH12 GH16				5h11 x 21
Order-No.	-		-	3101399
GH20 GH...-10	100	22 x 8,5	10 x 33,5	5h11 x 23
Order-No.	3101522		3101397	3101400
GH25 GH...-12	120	24,5 x 9,5	10 x 33,5	5h11 x 23
Order-No.	3101523		3101397	3101400
GH30	140	28 x 11	12 x 38	5h11 x 26
Order-No.	3101524		3101398	3101401
GH40 – GH100	120	28 x 11	12 x 38	5h11 x 26
Order-No.	3101525		3101398	3101401





Lever clamps classiX – GSH and Lever clamps – GH – old version up 28.02.10

suitable for series G...H, GSH







	Sliding arm cpl.		Lever pressure plate cpl.	Trigger cpl.
				
				2 pcs.
	Throat depth mm	For rail mm	Bolt-Ø x l mm	Bolt-Ø x l mm
G12H / G...S6H G16H / G...S8H GSH12 – GSH16				5h11 x 21
Order-No.	-		-	3101399
G20H / G...S10H GSH20	100	19,5 x 9,5	10 x 33,5	5h11 x 23
Order-No.	3101333		3101397	3101400
G25H / G...S12H GSH25 GU-H	120	22 x 10,5	10 x 33,5	5h11 x 23
Order-No.	3101334		3101397	3101400
G30H GSH30	140	25 x 12	12 x 38	5h11 x 26
Order-No.	3101335		3101398	3101401
G40H – G60H GSH40 – GSH60	120	25 x 12	12 x 38	5h11 x 26
Order-No.	3101336		3101398	3101401
G80H – G100H	120	27 x 13	12 x 38	5h11 x 26
Order-No.	3101337		3101398	3101401

BESSEY Accessories and spare parts list 2025/2026

High-performance clamps – SLM and SGM – new version from 01.07.08

	Sliding arm cpl.		Combi set (Screw + special pressure plate + pressure pin)		Screw		Tommy bar accessory KA
							
			without hexagonal bolt		with hexagonal bolt		2 pcs.
	Throat depth mm	For rail mm	Acme thread mm	Tommy bar Ø x Length mm	Acme thread mm	Tommy bar Ø x Length mm	
SL...M	120	28 x 11	18 x 5	10 x 120			
Order-No.	3101521		3100398		-		3101194*
SG...M	140	34 x 13	20 x 5	11 x 120	20 x 5	11 x 120	
Order-No.	3101407		3100399		3101815		-



High-performance clamps – SLM/SGM/STBM/STBVC/SGU/STBU/STBS

	Regular special pressure plate swivelling		Regular special pressure plate fixed		Rough surfaced special pressure plate swivelling		V-groove special pressure plate swivelling		Socket/bushing with spring ring	Cotter STBS
										
										2 pcs.
	Hole of screw mm	Pin mm	Hole of screw mm	Pin mm	Hole of screw mm	Pin mm	Hole of screw mm	Pin mm	Thread	
SLM / SGM STBM / STBVC SGU	12	5 x 20	12	5 x 20	12	5 x 20	12	5 x 20		
Order-No.	3100736		3102127		3101192		3101193		-	-
STBU	12	5 x 20			12	5 x 20	12	5 x 20		
Order-No.	3100737		-		3101192		3101193		-	-
STBS	12	5 x 20							M 24	
Order-No.	3100737		-		-		-		3100579	3101788

High-performance clamps – STBVC/STB/STBS





High-performance clamps classiX – GSL und GSM

High-performance clamps – SGL and SGM – old version up 30.06.08





	Sliding arm cpl.		Combi set (Screw + special pressure plate + pressure pin)		Tommy bar accessory KA
					
	Throat depth mm	For rail mm	Acme thread mm	Tommy bar Ø x Length mm	2 pcs.
SGL...M / GSL	120	27 x 13	18 x 5	10 x 120	
Order-No.	3101338		3100398		3101194*
SG...M	120	30 x 15	20 x 5	11 x 120	
Order-No.	3101329		3100399		-
SG30M / GSM / SGU	140	30 x 15	20 x 5	11 x 120	
Order-No.	3101330		3100399		-
SG...T20M	200	30 x 15	20 x 5	11 x 120	
Order-No.	3101331		3100399		-
STB...M / STBU	175	40 x 20	22 x 5	11 x 180	
Order-No.	3101332		3100400		-
STBS	200	50 x 25	M24	18 x 345	
Order-No.	3101798		3100401		-
STBVC	100	40 x 20	22 x 5	11 x 180	
Order-No.	3101882		3100400		-

BESSEY Accessories and spare parts list 2025/2026



Versatile clamp set 3 m opening SLV, GSV

	Rail		Sliding arm cpl. with wooden handle		Sliding arm cpl. with lever handle		Sliding arm cpl. with tommy bar		Tommy bar accessory KA
									 2 pcs.
	Opening mm	Rail mm	Throat depth mm	For rail mm	Throat depth mm	For rail mm	Throat depth mm	For rail mm	
SLV	1000	27 x 13	120	27 x 13	120	27 x 13	120	27 x 13	
Order-No.	3101731		3101426		3101337		3101338		3101194*
SLV	1500	27 x 13	120	27 x 13	120	27 x 13	120	27 x 13	
Order-No.	3101732		3101426		3101337		3101338		3101194*
SLV	2000	27 x 13	120	27 x 13	120	27 x 13	120	27 x 13	
Order-No.	3101733		3101426		3101337		3101338		3101194*





GSV	3000	30 x 15					120	30 x 15	
Order-No.	3101612		-		-		3101329		-
GSV	3000	30 x 15					140	30 x 15	
Order-No.	3101612		-		-		3101330		-
GSV	3000	30 x 15					200	30 x 15	
Order-No.	3101612		-		-		3101331		-

	Regular special pressure plate swivelling		Regular special pressure plate fixed		Rough surfaced special pressure plate swivelling		V-groove special pressure plate swivelling		End fastenings
									 2 pairs
	Hole of screw mm	Pin mm	Hole of screw mm	Pin mm	Hole of screw mm	Pin mm	Hole of screw mm	Pin mm	
SLV / GSV	12	5 x 20	12	5 x 20	12	5 x 20	12	5 x 20	
Order-No.	3100736		3102127		3101192		3101193		3101782

Claw clamp – new version from 01.04.12







	Sliding arm cpl.		Screw cpl.	
				
	Throat depth mm	For rail mm	Acme thread mm	Tommy bar Ø x l mm
GRA...12	120	28 x 11	18 x 5	8 x 110
Order-No.	3101590		3100562	

Toggle clamps STC

	Screw set cpl.	For multifunction tables Adapter	For welding tables			
			Toggle clamp adapter		Extension	
		 1 Cylindrical screw DIN 912 M 8x35 1 Lock pin D20x17 1 Knurled nut M8				
			Bolt Ø mm	Bolt Ø mm	Bolt Ø mm	Adjusting range
STC-VH20 / STC-HH20 STC-IHH15			16	28		
Order-No.	3101627	-	TW16A-STC	TW28A-STC	-	
STC-HV20 / STC-HA20 STC-IHA15						
Order-No.	3101627	-	-	-	-	
STC-VH50 / STC-HH50 STC-IHH25			16	28		
Order-No.	3101589	STC-SET-T20	TW16A-STC	TW28A-STC	-	
STC-HH70			16	28		
Order-No.	3101588	STC-SET-T20	TW16A-STC	TW28A-STC	-	
TW16A-STC TW16VAD / TWVAD					16	15-200
Order-No.	-	-	-	-	TW16X	
TW28A-STC TW28VAD / TWVAD					28	15-300
Order-No.	-	-	-	-	TW28X	

BESSEY Accessories and spare parts list 2025/2026





Clamping elements with variable throat depth TWV

	Rail		Cross holder cpl.	Sliding arm cpl. with 2-component plastic handle		Sliding arm cpl. with Tommy bar		Sliding arm cpl. with lever handle		Workbench adapter
										
	Clamping height mm	Rail mm	For rail mm	Throat depth mm	For rail mm	Throat depth mm	For rail mm	Throat depth mm	For rail mm	Suitable for
TWV16	200	22 x 8,5	22 x 8,5	30-150	22 x 8,5	30-150	22 x 8,5	60-150	22 x 8,5	19 mm/3/4"
Order-No.	3101740		3101744	3101741		3101742		3101743		TW16AW19
TWV16	200	22 x 8,5	22 x 8,5	30-150	22 x 8,5	30-150	22 x 8,5	60-150	22 x 8,5	20 mm/13/16"
Order-No.	3101740		3101744	3101741		3101742		3101743		TW16AW20
TWV16	200	22 x 8,5	22 x 8,5	30-150	22 x 8,5	30-150	22 x 8,5	60-150	22 x 8,5	-
Order-No.	3101740		3101744	3101741		3101742		3101743		-
TWV16	200	22 x 8,5	22 x 8,5	30-150	22 x 8,5	30-150	22 x 8,5	60-150	22 x 8,5	30 mm/1 3/16"
Order-No.	3101740		3101744	3101741		3101742		3101743		TW16AW30
TWV28	300	28 x 11	28 x 11	40-175	28 x 11	40-175	28 x 11	110-175	28 x 11	-
Order-No.	3101706		3101710	3101707		3101708		3101709		-

Horizontal pull-down clamp WNS-SET-MFT

Bench dog for multifunctional tables	
 <p>4 x bench dog 4 x knurled nut</p>	
Bolt-Ø mm	
20	
WNS-SET-MFT	
Order-No.	BH-MFT

Clamping elements with fixed throat depth TW



	Rail		Sliding arm cpl. with 2-component plastic handle		Sliding arm cpl. with Tommy bar		Sliding arm cpl. with lever handle		Workbench adapter
									
	Clamping height mm	Rail mm	Throat depth mm	For rail mm	Throat depth mm	For rail mm	Throat depth mm	For rail mm	Suitable for
TW16	200	22 x 8,5	100	22 x 8,5	100	22 x 8,5	100	22 x 8,5	19 mm/3/4"
Order-No.	3101740		3101516		3101441		3101522		TW16AW19
TW16	200	22 x 8,5	100	22 x 8,5	100	22 x 8,5	100	22 x 8,5	20 mm/13/16"
Order-No.	3101740		3101516		3101441		3101522		TW16AW20
TW16	200	22 x 8,5	100	22 x 8,5	100	22 x 8,5	100	22 x 8,5	-
Order-No.	3101740		3101516		3101441		3101522		-
TW16	200	22 x 8,5	100	22 x 8,5	100	22 x 8,5	100	22 x 8,5	30 mm/1 3/16"
Order-No.	3101740		3101516		3101441		3101522		TW16AW30
TW28	300	28 x 11	120	28 x 11	120	28 x 11	120	28 x 11	-
Order-No.	3101706		3101519		3101450		3101525		-
TW28	300	28 x 11	140	28 x 11	140	28 x 11	140	28 x 11	-
Order-No.	3101706		3101518		3101447		3101524		-

BESSEY Accessories and spare parts list 2025/2026





Clamping elements with special pressure plate TWM28

	Sliding arm cpl. with tommy bar and special pressure plate		Regular special pressure plate swivelling		Regular special pressure plate fixed		Rough surfaced special pressure plate swivelling		V-groove special pressure plate swivelling	
										
	Throat depth mm	For rail mm	Hole of screw mm	Pin mm	Hole of screw mm	Pin mm	Hole of screw mm	Pin mm	Hole of screw mm	Pin mm
TWM28	120	28 x 11	12	5 x 20	12	5 x 20	12	5 x 20	12	5 x 20
Order-No.	3101521		3100736		3102127		3101192		3101193	

Clamping elements TW28GRS / TWVAD / TWA-STC / TW28AV

	Rail		Gripping arm cpl.		Extension	
						
	Clamping height mm	Rail mm	Throat depth mm	For rail mm	Bolt Ø mm	Adjusting range mm
TW28GRS	300	28 x 11	120	28 x 11		
Order-No.	3101706		3101590		-	
TWVAD TW16VAD TW16A-STC					16	15-200
Order-No.	-		-		TW16X	
TWVAD TW28VAD TW28A-STC TW28AV					28	15-300
Order-No.	-		-		TW28X	

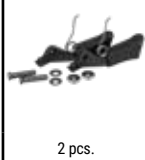

Machine table clamps BAS, BS, SGHS

	Clamping arm	Pressure shoe	Spindle	Sliding arm cpl.		Trigger cpl.
		 4 pcs.	 2 pcs.			 2 pcs.
				Throat depth mm	For rail mm	Bolt-Ø x l mm
BAS...9-4						
Order-No.	3101428	3101431	3101726	-	-	-
BAS...10-6						
Order-No.	3101429	3101431	3101726	-	-	-
BSP...10-6						
Order-No.	3101430	-	3101726	-	-	-
BS2N / BS3N						5h11 x 26
Order-No.	-	-	-	-	-	3100747
BS4N						5h11 x 26
Order-No.	-	-	-	-	-	3100748
BS5N / BS6N SG-HS				140	30 x 15	
Order-No.	-	-	-	3101432		-

Box clamp KS

Pressure piece	
	
4 pcs. in bag	
KS	
Order-No.	3101845

Area pressure clamps FK

Screw cpl. with wooden handle		Protection cap	
			
Acme thread mm		Throat depth mm	
FK16-8		2 pcs.	
Order-No.	-	3101790	
FK...-10	16 x 4	80	
Order-No.	3101386	3101789	

GearKlump GK

Pressure plate with protection cap	
	
5 pairs	
Ø mm	
GK	26
Order-No.	3101840

BESSEY Accessories and spare parts list 2025/2026

One-handed clamp EHZ

	Protection cap set	Protection cap set
		
	5 pairs	10 pcs.
	Ø mm	mm
EHZ...-2K	32	
Order-No.	3101402	-
EZS...-8		40 x 48
Order-No.	-	3101841





One-handed clamp EZ

	Protection cap set	Clamping attachment
		
	10 pcs.	2 pcs.
EZM		
Order-No.	3101959	3101962
EZL		
Order-No.	3101960	-
EZXL		
Order-No.	3101961	-

One-handed clamp EZ360

	Protection cap set
	
	6 pcs.
EZ360	
Order-No.	3102055

Rafter clamp SPZ60K und SPZ80K

	Sliding arm cpl.	Combi set (Screw + special pressure plate + pressure pin)		Screw		Tommy bar accessory KA	Pressure plate with protection cap
		 without hexagonal bolt		 with hexagonal bolt		 2 pcs.	 4 pairs
	For rail mm	Acme thread mm	Tommy bar Ø x Length mm	Acme thread mm	Tommy bar Ø x Length mm		
SPZ60K	27 x 13	18 x 5	10 x 120				
Order-No.	3101338	3100398		-		3101194*	3101188
SPZ80K	30 x 15	20 x 5	11 x 120	20 x 5	11 x 120		
Order-No.	3101330	3100399		3101815		-	-

Rafter clamp SPZ80K

	Regular special pressure plate swivelling		Regular special pressure plate fixed		Rough surfaced special pressure plate swivelling		V-groove special pressure plate swivelling	
								
	Hole of screw mm	Pin mm	Hole of screw mm	Pin mm	Hole of screw mm	Pin mm	Hole of screw mm	Pin mm
SPZ80K	12	5 x 20	12	5 x 20	12	5 x 20	12	5 x 20
Order-No.	3100736		3102127		3101192		3101193	

BESSEY Accessories and spare parts list 2025/2026





Grip pliers GRZ

	Protection cap for GRZ10 and GRZ20	Protection cap for GRZRO
		
	4 pcs.	2 pairs
GRZ10 – GRZ20		
Order-No.	3100576	–
GRZRO		
Order-No.	–	3101547

KliKlamp KLI

	Protection cap for moveable jaw & for fixed jaw	
		
	10 pairs	
	For Ø mm	For width mm
KLI	25,5	23
Order-No.	3101393	

Mini Vice S10 / Angle clamp WS

	Table clamp		Table clamp		Table clamp		Table clamp	
								
	Ø 8 mm		Ø 8 mm		Ø 8 mm		Ø 8 mm	
	Opening mm	Throat depth mm	Opening mm	Throat depth mm	Opening mm	Throat depth mm	Opening mm	Throat depth mm
S10-ST / WS3	60	22	60	28	100	50	150	50
Order-No.	TK6		RB269		LM10/5R8		LM15/5R8	

One-handed table clamp EZR

	Protection cap set	Clamping attachment	Adapter for guide rails (Bosch, Mafell)
			 
	10 pcs.	2 pcs.	2 pcs.
EZR			
Order-No.	3101959	3101962	3102016

All-steel table clamp GTR



	Protection cap for moveable jaw & for fixed jaw	
		
	10 pairs	
	For Ø mm	For width mm
GTR	22	17
Order-No.	3101391	

BESSEY Accessories and spare parts list 2025/2026

Band clamps BAN

Clamping strap spare part/enlargement	
	
BAN700 / SVH	strap 7100 m, 2 buckles
Order-No.	3100832

One-handed edge clamp EKT

	Repair kit	Jaw cpl. with push rod
		
	3 pcs. protection caps 6 pcs. of large jaws	2 pairs
EKT55		
Order-No.	3101403	3100998

Edge clamp KT

Screw cpl.	
	
KTS-1	
Order-No.	3101799

Kantenfix KF and panel carrier KFP

Jaws	
	 <p>1 pair incl. spring</p>
KF2	
Order-No.	4102100
KF4	
Order-No.	4102056
KFP	
Order-No.	4102057*

* suitable for KFP from 2018 (red jaws)





Seaming Tools PS

	Vacuum adaptor	Rubber pad	Handle
			
	<p>Ø mm</p>	<p>Ø mm</p>	
PS55	120		
Order-No.	3101839	-	-
PS130		210	
Order-No.	-	3101685	3101686

BESSEY Accessories and spare parts list 2025/2026**Door frame assembly device TMS**

	Clamping piece
	
TMS	
Order-No.	3100983

Door frame clamp TU

	Auxiliary clamp incl. slide piece	Bracket	Extension	Felt strip	Bag
				 4 pcs.	
TU					
Order-No.	3101752	3101764	TUX	3101632	3101762



Door frame straightening clamp TFM

	2 x spindle with loose pad and protection cap
	
TFM	
Order-No.	3101408

Window installation clamp FRK

2 x spindle with loose pad and protection cap	
	
FRK	
Order-No.	3101409

Sash clamps TB

	Pressure jaw		Screw guide	Clamping jaw	Screw set TB
					
	Jaw width mm	Jaw height mm	Acme thread mm		
TB	60 (80)	48	18 x 5		
Order-No.	3101793		3101792	3100920	3101405

Sash clamps TL

Pressure jaw	
	
TL	
Order-No.	3101877

BESSEY Accessories and spare parts list 2025/2026

Telescopic drywall support STE, ST





	Multi-function/ laser fixture	Support plate	Ceiling tripod attachment	Construction tripod	Combi-bag
					
STE					
Order-No.	STE-LH	STE-SP35	STE-DS	STE-BS	-
ST					
Order-No.	STE-LH	STE-SP35	STE-DS	STE-BS	-
STE300 STE370					
Order-No.	-	-	-	-	STE-BAG

Telescopic drywall support STE, ST





	Replacement contact surface	Locking lug ST	Star grip screw
			 4 pcs.
STE			
Order-No.	3101952	-	-
ST			
Order-No.	3101952	3101969	-
STE-SP35			
Order-No.	-	-	3101970

BESSEY Accessories and spare parts list 2025/2026



Compound leverage snips

	Repairing set 08/22A 27/29/123S	Repairing set 17A-2	Lower hold complete 123S	Pouch
				
				for 3 snips
D08 ... D16A D22A D27AH-TIN/L				
Order-No.	R032	-	-	7002464
D16 / D16L / D16S				
Order-No.	-	-	-	7002464
D27 ... D29 ...				
Order-No.	R001	-	-	7002464
D17A-2/L				
Order-No.	-	R043	-	7002464
D123S				
Order-No.	R001	-	R042	7002464

Standard tin snips

	Screw complete M6 D8 x 24	Screw complete M6 D8 x 26	Screw complete M8 x1 x 22	Pouch
				
	2 pcs.	2 pcs.	2 pcs.	for 3 snips
D101-200 – D101-250 D201-200 – D201-250 D102-225 D202-225 D107-225 – D107-275 D207-225 – D207-275 D114-250 – D114-275 D214-250 – D214-275 D159-200 – D159-250				
Order-No.	R034	-	-	7002464
D102-250 – D102-300 D202-250 – D202-300 D106-250 D106A-250 D107-300 – D107-350 D207-300 – D207-350 D208-275 D209-275 D114-300 D214-300 D159-300 – D159-350				
Order-No.	-	R035	-	7002464
D116-260 – D116-280 D216-260 – D216-280 D216-260-B-SBSK D216-280-B-SBSK D118-300 – D118-350 D218-300 – D218-350 D416-280 D418-300 – D418-350				
Order-No.	-	-	R036	7002464
D407-275 – D407-300				
Order-No.	-	-	-	7002464

**Folding utility knife**

	Standard blade	Hook blade	Linoleum blade
	 <p>10 pcs.</p>	 <p>10 pcs.</p>	 <p>5 pcs.</p>
DBKPH DBKWH DBKAH			
Order-No.	DBK-T	DBK-H	DBK-L